



Integration Environmental Aspects onto Customer Requirement to Develop Green Quality Function Deployment

Maryam Khalid Abdul Wahid^a, Dr. Lamyaa Mohammad Dawood^b

^a University of Technology Department of Production & Metallurgy, Industrial Engineering, Baghdad, Iraq

^b University of Technology Department of Production & Metallurgy, Industrial Engineering, Baghdad, Iraq

PAPER INFO

Paper history:

Received 1/9/2019

Received in revised form

15/10/2019

Accepted 9/12 /2019

Keywords:

GQFD, HOQ, TCs, VOC, VOE,

AHP, Pareto chart

ABSTRACT

The extensive global competition between companies and the development of new industrial technologies have greatly contributed to the current competitive conditions. Like industrial companies, customers demand high quality products, low prices and better performance. This fierce competition has led to concerns about improved product design. This development is based on GQFD. Model of this developed Water pump is employed by CAD solid model (version 7). In order to achieve competition and high quality and high performance in the Iraqi market. GQFD demonstrates the balance between product development and environmental protection. Used a water pump for a home air cooler as a case study. Data is collected and distributed using personal interview methods and questionnaire forms to indicate customer requirements. The data is then analyzed using Pareto chart and AHP to prioritize customer needs. These priorities are then placed in house of quality and matrix of relationships between customer requirements and technical characteristics is established. The product has been developed from electrical to mechanical, in addition to using accumulated, stored and recycled materials; it also saves 20% of energy, thereby combining energy reduction with the use of damaged materials and their re-entry into work. As a result, the cost of pump manufacturing will decrease

© 2014 Published by Anbar University Press. All rights reserved.

1. Introduction

The environmental issues were presented for developing novel products particularly since the year 1990. Terms which have been typically indicated are the environmental design or eco-design. Eco-design could be specified as product development that involve the environmental interests, considering environmental needs for allowing reducing environmental effects in the life cycle of products. For the purpose of improving the product's environmental aspects, many practices have been taken into account as straightforward approaches, guidance and tools for more complex methods. A main benefit to use QFD in the eco-design is the

capability of reviewing environmental needs in the same time as the development of novel products through translating such needs to design specifications [1].

Recently, the environmentally friendly products were of high interest due to the increase in awareness of consumers regarding environmental issues, increase in the cost regarding waste disposals accentuated the significance related to the development of environmentally friendly products[2].

* Corresponding author: Maryam Khalid Abdul Wahid ; maryam1876@yahoo.com ; +964-7823658823

Eco-design indicates integration related to the environmental considerations to the development of products which might indicate the way of creating smart products or techniques, interesting designs and efficient system solutions [3].

QFD presented in Japan via Yogi Akao (1966) and utilized via Toyota. QFD result in products which satisfy all the requirements of consumers. QFD utilizing Voice of Customer (VOC) and technical properties related to products or processes as inputs[4,5].

Also, the QFD might indicated as “house of quality” and often as “listening to the voice of the customer”[6].

QFD that is transformed to GQFD taken into account the environmental aspects as effective tool to develop environmentally friendly products. With regard to

GQFD, present the environmental necessities process development and product design [3].

GQFD has been utilized for analyzing the products on the basis of standards which are valued the most by customers in addition to green design guidelines in the development of products, there are 6 main elements related to GQFD as follows [3]:

1. To determine Environmental VOC (WHAT's).
2. The way to achieve necessities, Technical Characteristics (How's).
3. Relation between HOW's and WHAT's which should be tackled.
4. Target values for necessities.
5. Relations between the way of meeting requirements.
6. Quantification related to the requirement's significance. As can be seen in figure (1).

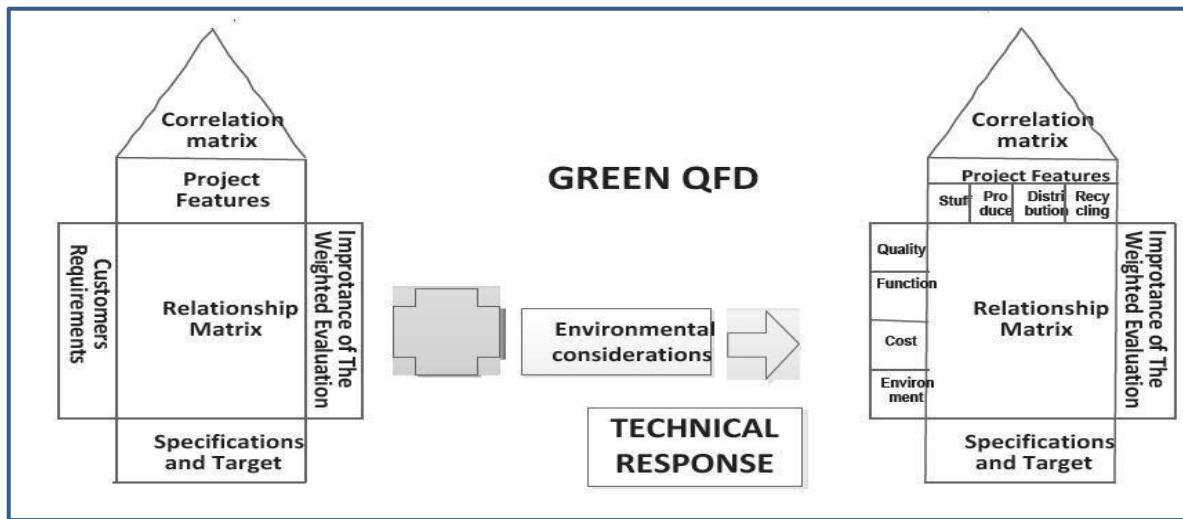

Fig (1) Green Quality Function Deployment [7]

Environmentally Responsible Design

Environmental issues have been presented in the development of novel products particularly since 90's as QFD is transformed into GQFD considering environmental factor. George E. Dieter, and Linda C. Schmidt, identified the following Environmental necessities related to products [8].

1. Disassembled easily.
2. Could be recycled.
3. Consists of certain recycled materials.
4. Utilize identifiable as well as recyclable plastics.
5. Reduce using natural materials and energy in its manufacture.

6. Created without creating dangerous waste.
7. Avoid using dangerous materials.
8. Reducing the chemical emissions of products.
9. Reducing the energy consumption of products.

Description of design process

Morris Asimw has been one of the researchers who provided thorough description regarding the total process of design which he referred to as the design's morphology, there are 3 design phases [9];

1. Detail design,
2. Embodiment design,
3. Conceptual design. The types related to the Designs Engineering are as follows:
 - 1) Original design, which is also referred to as the innovative design, such design is at the top of hierarchy, it uses innovative and original concept for achieving needs.
 - 2) Adaptive design, such form happens in the case when the design team adapt recognized solutions for satisfying distinctive needs for producing new applications.
 - 3) Re-design, engineering design has been used for improving the present design.

The task could be redesigning component in product which is failing in service, or redesigning component for reducing its manufacturing costs. Regularly, redesign can be achieved with no change in working concepts of principles regarding original design.

Classifying Customer Requirements

In 1980s, Kano model has been presented, it was important model to evaluate service attributes or products and was utilized in many industries, such model set that key product or service attributes are associated to the satisfaction of customers. The main aim of such model is analyzing the type of service attributes or products and classify such attributes to various categories [10].

Customer requirements differ from one another. Which in fact indicates that those requirements are differently important from one person to another. The design team has to specify these requirements which are of the highest importance for ensuring product's success in the target market and has to make sure that these requirements are fulfilled by the product. One of the best tools for the visual partitioning of customer requirements to categories is the Kano diagram, which will permit their prioritizing [8].

This Customer Satisfaction Model performs the classification of the features of a product according to

the way they are viewed by the customer and their impact on the satisfaction of customers. This categorization is beneficial to guide the decisions of the design, due to the fact that they specify when good is good enough, and when more is better. Which is why, the analysis of those requirements is equally significant as receiving them. There are customer requirement types that should be taken under consideration, as depicted below in figure 2 are threshold Requirements, performance Requirements, excitement Requirements.

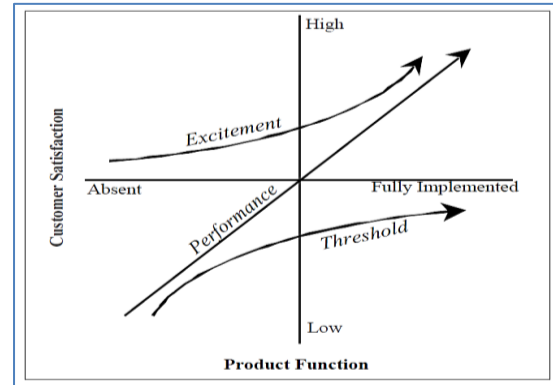

Fig. (2): Kano model [11]

VOC can be obtained directly from the customer, from the market as a whole, or from the end users of the good or service, Some explicit needs that customer might have are Technical requirements , Cost , performance of quality, Ease of install .Implicit needs that customer might have are Functionality , Improvement , safety, power consumption, Weight, Aesthetics[11].

These customer requirements in the form of WHAT's and HOW's are shown in the matrix of GQFD house. Requirements and attributes have to be approached from the environmental viewpoint throughout an entire lifecycle of a product, integrated these environmental aspects to a group of feasible green VOC and TCs .In the mathematical aspect , The equations are used below in Table (1) to get the absolute importance and Relative importance for engineering characteristics and environmental customer requirement [4].

Table (1) Equations of the Absolute and the Relative Importance

Absolute importance of EC		Relative importance of EC	
	$AI_j = \sum_{i=1}^m w_i * f_{ij} \dots \dots \dots (1)$		$RI_j = AI_j / \sum_{k=1}^n AI_k \dots \dots \dots (2)$
AI_j	Absolute importance of EC_j (j=1, ..., n)	RI_j	Relative importance of EC_j
f_{ij}	Relationship coefficient between EC_j and ECR_i		

Literature Review

Samah Ali Awfi [4] : The aim of thesis is to develop and apply approach which represents a step by step procedure that is based on selecting and implementing the suitable statistical techniques in order to evaluate, analyze and enhance process capability.in the State Company for Electrical Industries (SCFEI).The result of about electrical water pump (Cp value for external diameter of rotor has been increased from 0.48 to 0.65), (Cp value for shaft diameter has been increased from 0.63 to 0.72. and (Cp value for Pressing Dimension has been increased from 0.558 to 0.594, Cpk from 0.55 to 0.555 and Cpm from 0.44 to 0.504). The result of this external diameter of rotor, shaft diameter and pressing dimension are not capable of meeting the required specification since in all cases the process capacity indices (Cp, Cpk and Cpm) values are below 1. These improvements will affect reducing the number of defectives in production processes and as a result the cost of final product will declined.

Osama Malik Mohammed [12]: A process of executing analytical Design for Six Sigma using an electromechanical product (air-cooler water pump) as case for application in the State Company for Electrical Industries. It is identification of VOC, benchmarking with the competitive products and designing – redesigning the product. used the important tools like Design for manufacturing and assembly (DFMA) and Quality Function Deployment (QFD) are applied to improve the product .The product is redesigned to satisfy customer requirements and simplifying the product by decreasing number of parts from 12 parts for current design to 7 parts in modified design. It’s also resulted in increasing efficiency for the current design from 12% into 44% for the modified design through decreasing assembly time using mentioned design tools that mostly conform to the voice of customer (VOC) along with minimizing the costs.

Chandak et.al. [13]: Air cooler working without water pump, less air cooler rather than water’s circulation. A screen to humidify air has been created,

with an approach for rotating screen via water which is stationary, also the screen will be continuously rotated through the water to make each one of the screen parts wetted for humidifying air sucked via fan. Air cooler work with no water pump and saving electric energy, pump less cooler provide temperature drop of 30-degree F in fifteen minutes. It was indicated that the electrical consumption has been decreased by 23.5 percent, also water consumption has been decreased by average (59.25 percent), yet the water consumption will increase with the increase in the atmosphere temperature in which the cooler is kept. The performance tests which have been conducted on pump less air cooler indicated that the effectiveness of such cooler fairly comparable high with traditional cooler in market.

Salman and Al-Makhul et.al. [14]: In using air cooler type BF3 size 2500 m³/ hr. of two speeds motor. Researchers add another water pump to the first water pump in order to increase the amount of water drop over pads. Results show that addition of another Water pump is highly significant on cooling efficiency (F1, 19 = 15.98, p = 0.0018). Furthermore, addition of anther water pump has significant effect on inside temperature which improve the performance of Air cooler.

Dr. Khalil I. Mahmoud [15]: The aim of this research is emphasis that such techniques should be strongly. a new technique in representing the House of Quality matrix by using Auto Cad program in an electrical motor (1/4 HP) in our case study because of its wide use, especially at summer season in the air coolers. The propose of this research to the company to improve the product in efficiency, maintenance, safety and cost to satisfy the customers. It is strongly needed for using the house of quality in the institutes specially the ones that are dealing with the customers directly.

He Yizhou [16]: Studied the way of reducing central air-conditioning energy consumption, also it has been considered as case study related to enhancement of the Nanchang HKLS air conditioning system in china. Energy-saving measures, that are

regulating the quality related to air-conditioning through decreasing cooling load demand. The approach of energy-saving is improving the effectiveness related to the system via enhancing the design related to central air conditioning as well as the coordination related to controlling devices. Five percent – ten percent in whole energy-saving regarding the central air conditioning system.

Case study

Green Quality Function Deployment (GQFD) is used to develop Iraqi Water pump into power saving Water pump, the method of collecting information about voice of customer (VOC) and voice of environment (VOE) are through the questionnaire .100 copies of questionnaire are distributed for a sample of customers to answer them in Baghdad since it is the capital of Iraq with growing population (expected to be the number of Iraqi population in Baghdad 12 million population in 2020 [17].

The data was analyzed using Analytic Hierarchy Process (AHP) to obtain priorities of voice of customer. Where the data was collected from the questionnaire form and get a statistics of the customer requirement, were as follows: shows their direct and indirect concern toward different environmental aspects are; reduction of energy use and natural materials on its manufacturing, product energy consumption, personal and environmental safety, and product chemical emissions. After the data was collected from the questionnaire, data was classification according to customer requirements using Kano model as following in Fig(3).

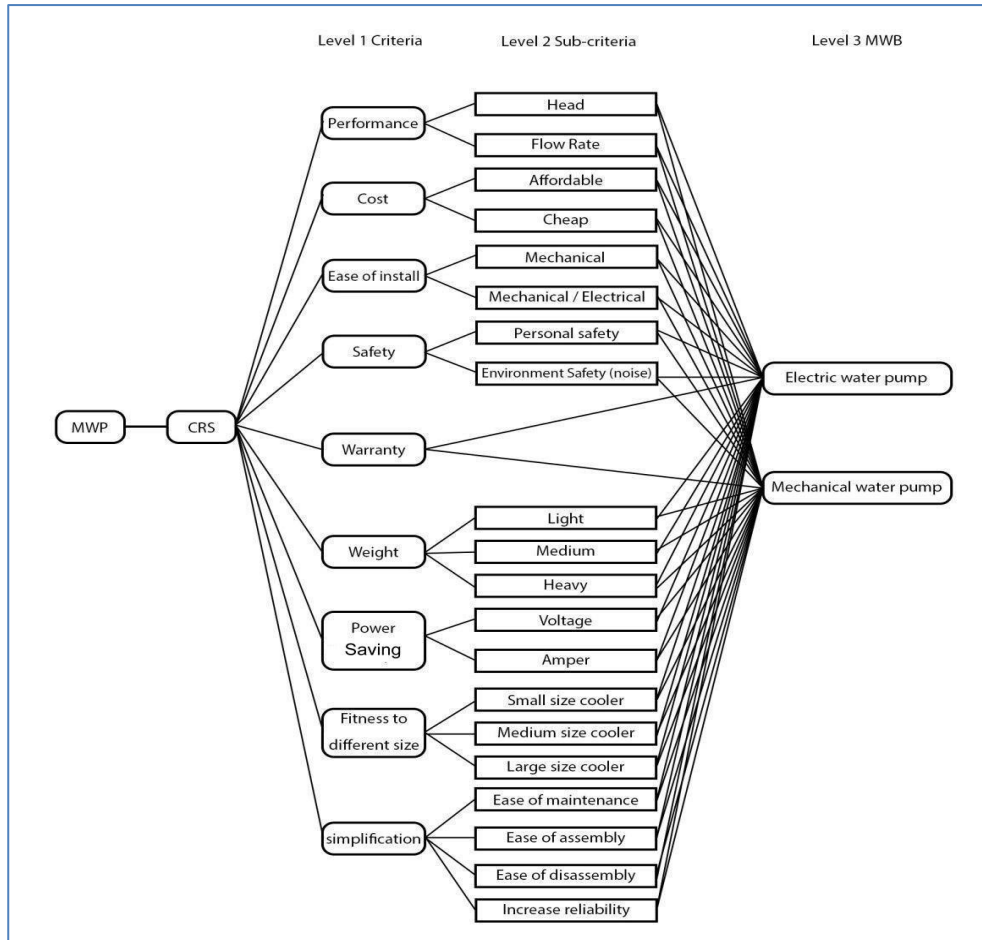

Fig.(4) AHP for Customer Requirement

As a result of the use of AHP to analyze the data and prioritize the requirements of customers, it is found that the priority ratio is shown as follows in Fig (5).

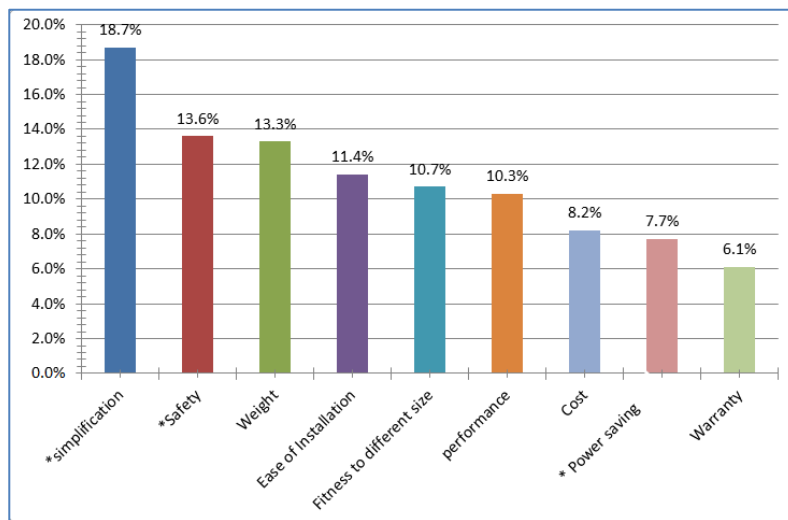

Fig.(5): Pareto Chart for prioritize Customer Requirements for first Questionnaire

From the above table obtained from the AHP process to prioritize customer requirements, 40% result from the total of priorities are directed toward environmental development (Indicates by *). Among these environmental priorities is (human and environmental) safety, which that count (13.6) %.

Safe products are the ones which doesn't result in loss of property or injury. The recall regarding unsafe products could be extremely costly with regard to tarnished reputation, replaced product, or product liability suits. Product should be manufactured, used, and disposed in a safe way. [8][9]

Furthermore, it could be noticed that, although most customers prefer to buy lower price product but they rather choice safety as Water pump is operating

in electrical / water environment. While warranty is of 6% value showing the least interesting requirement to customers. There are another reading of a second questionnaire where 100 questionnaires were distributed at retailer because there are different opinions by the customer (buyer).

A high percentage of the customer's voice was also obtained towards the environmental trend through the AHP process as well. 39.8% was obtained, which is approximately equal to the percentage obtained from the first questionnaire, indicating that the customer's voice has a majority vote towards development and improvement in a direction that is environmentally friendly and at the lowest cost ,as shown in Fig(6).

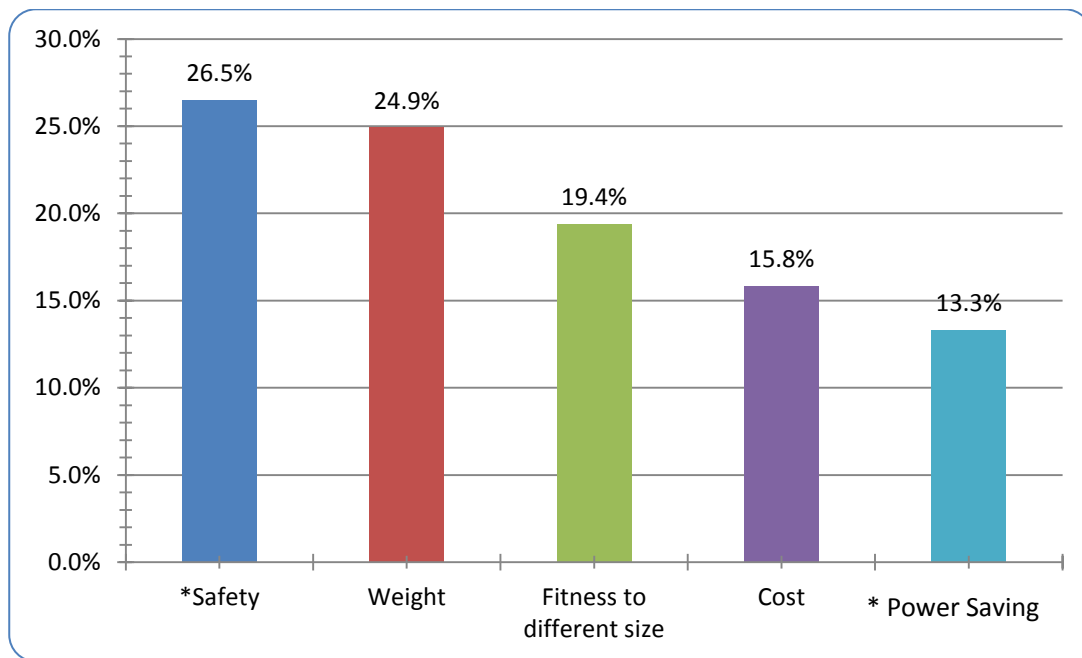

Fig .(5): Pareto Chart for prioritize Customer Requirements for Second Questionnaire

After collecting and analyzing information. These priorities are then placed in house of quality and a matrix of relationships between customer requirements (CRs) and technical characteristics

(TCs) is established, as shown below in Fig.(7) QQFD.

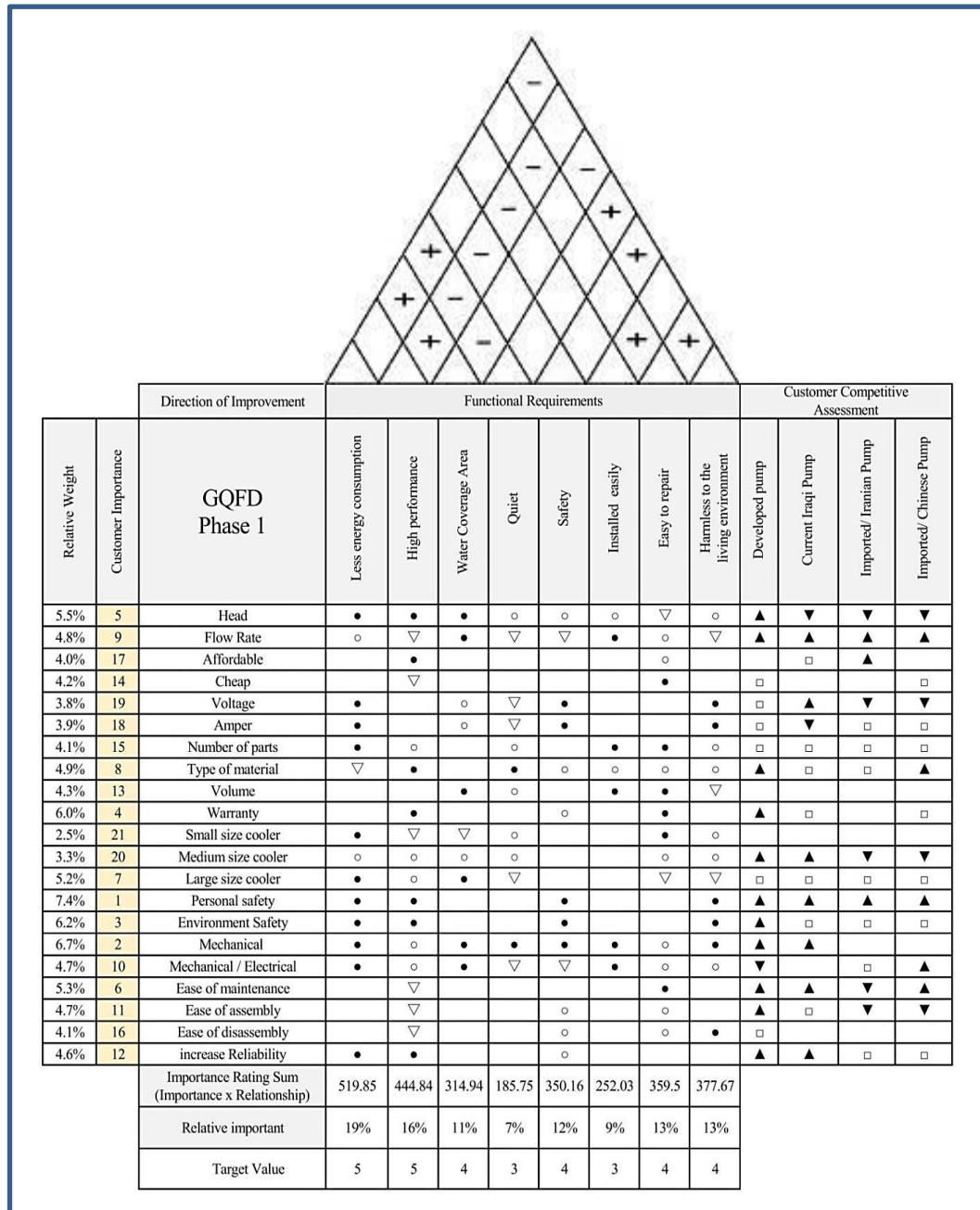

Fig (7): QQFD (House of Quality) for Power Saving Water Pump

As shown below the scheme for power saving water pump parts(2D) model as in Figure (8) using the Auto CAD software (version7).

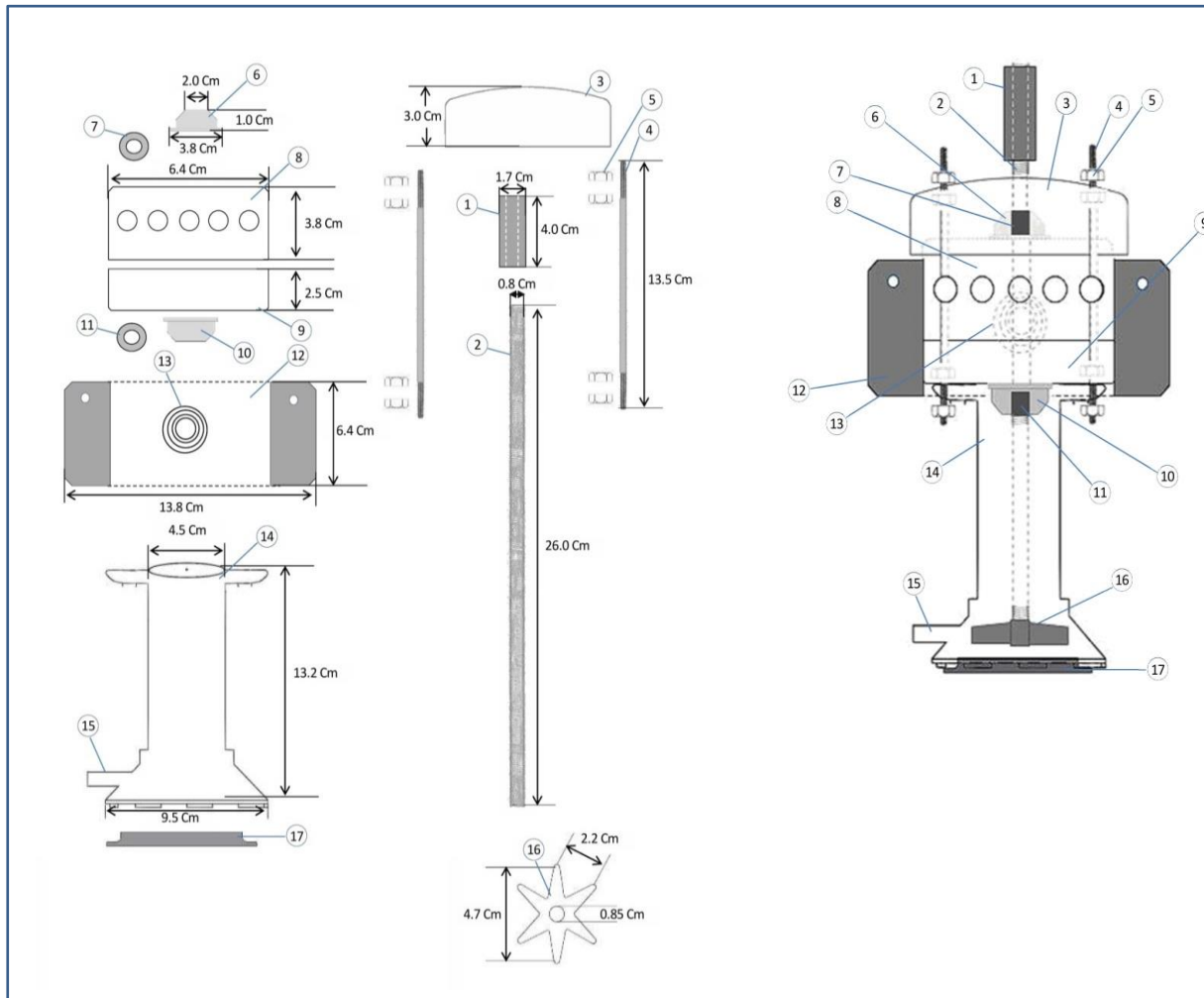

Fig. (4.5) Power Saving Water Pump (2D), and Detailed

Where the components of each part for Power saving water pumps as shown below in Table (2);

Table (2): Power saving Water pump Components

No.	Name	No.	Name
1	Rubber Slinger	10	Lower Slinger Cover
2	Shaft (Stainless Steel)	11	Cotton Oiled slinger
3	Top Plastic Cover	12	Piece Iron for installation
4	Extended Studs	13	Spiral Spring
5	Nut	14	Plastic Support base
6	Upper Slinger Cover	15	Exit slot water
7	Cotton Oiled Slinger	16	Plastic Impeller
8	Upper Iron Cover	17	Plastic impeller cover
9	Lower Iron Cover		

While the Components of Current Iraqi Water Pump as shown in Table (3).

Table (3): Components of Current Iraqi Water Pump

No	Name	No	Name
1	Stator (lamination)	12	Small Bushing
2	Rotor lamination	13	Fan
3	Shaft	14	Nuts
4	Bearing Cap	15	Rivets
5	Sheet Metal	16	Plastic Support base
6	alloy in rotor	17	Top plastic Cover
7	Copper strip	18	Final plastic Cover
8	Winding Wire	19	Impeller
9	P.V.C lead Wire	20	Plastic impeller cover
10	Clamp cell	21	Bottom end shield
11	Large Bushing	22	Top end shield

Development of the Water pump used in the Air cooler, Iraqi Water pumps are manufactured at State Company Of Electrical Industries (SCEI) in Baghdad/Iraq, by removed the electrical part, which represents the source of danger in the air coolers ,where it's safe to human during implementation, maintenance, assembly (during manufacturing), disassembly life cycle and use. The developed Water pump uses mechanical movement of the Air cooler as it is to be detached from both side using part (9) listed in Table (2). This movement does not affect to the

motor of air cooled due to the use part (1) in the Table (2) which touches the Air cooler and moves with its movement. This developed Water pump is suitable for all Air cooler sizes and for all speeds of motor. Material selection is a key element and Cost reduction is also a key component of successful design. Developed Water pump has been produced with lower cost, safe, with high head and high flow rate. Add to, lower current and power as shown in Table (4).

Table (4): Measurement of current, voltages and power of a fixed motor, for electric pump and Developed pump

	Motor Iraqi pump		Developed pump	
	Without load	With load	Without load	With load
voltage	220	220	None	220
current	2.06	2.32	None	1.85
power	453.2	510.4	None	407

Result and Analysis

1. Customer safety: Customer safety is a basic requirement in any product, so this development has provided us with a safe environment during the process of using the product where the safety rate is very high.
2. Ergonomics: The working environment of this developed product is ideal as it takes into account the green environment and improves it.
3. Costs and price of the developed product: The current price of this product is much better than the price of the product before its development.
4. Efficiency and specifications: The product developed with a very high efficiency is better

than the imported instance or at least compete in terms of efficiency, and it is less consumption of electric current, which provides a large electric power up to 20%.The technical specifications are much better than the imported instance, in terms of ease of installation, shelf life of the developed product, consumption and damage.

Conclusion

In a simple calculation we can conclude that the amount of current supplied by using the developed pump instead of the electric pump is $(2.32) - (1.85) = (0.47)$.

We subtract the amount of current consumed by the main motor with the developed pump of the current consumed by the main motor with the electric pump. So we get an extra stream, this amount of current is the quantity we provided using the developed pump.

Also conclusion , From Fig (5) shows the priority sequence of the customer's voice in the AHP process, We conclude that the customer gave a percentage of safety factor higher than the cost factor, although most customers prefer to buy at the lowest prices and this indicates that the safety factor is better at the customer, which shows that the water pump is one of the most dangerous electrical appliances that deal with electricity and water ,This is a very serious risk to people's safety.

References

- [1] Shubham Joshi, Payal Bhargava; "Waste Management Integration with Green Quality Function Deployment (G-QFD) for Healthcare Centre", Production Engineering Archives V. 22 ,pp.(45-49),2019.
- [2] Chensong Dong, Chuck Zhang and Ben Wang; "Integration of Green Quality Function Deployment and Fuzzy Multi-Attribute Utility Theory-Based Cost Estimation for Environmentally Conscious Product Development", International Journal of Environmentally Conscious Design & Manufacturing, Printed in the U.S.A, Vol. 11, No. 1,2003.
- [3] Chung-Shing Wang, Pei-Yau Lin, Teng-Ruey Chang; "Green Quality Function Development and Modular Design Structure Matrix in Product Development", Proceedings of the 14th

- International Conference on Computer Supported Cooperative Work in Design,2010.
- [4] Samah Ali Awfi, "Application of Statistical Techniques to Improve the Ability of Processes", Master Thesis, University of Technology, Department of Production Engineering and Minerals, Industrial Engineering Branch, (2012).
- [5] Peetam Kumar Dehariya, Dr. Devendra Singh Verma; "An Application of Green Quality Function Deployment to Designing an Air Conditioner", Journal of Engineering Research and Applications, , Vol. 5, Issue 7, (Part - 2) July pp.(147-152),2015.
- [6] Lance B. Coleman; "The Customer-Driven Organization", CRC Press is an imprint of the Taylor & Francis Group, an informa business Boca Raton London New York, a productivity press book, 2014.
- [7] Heru Prastawa, Sri Hartini, Mohamat Anshori, Siechara Hans, Christoper Wimba; "Integration between Green Quality Function Deployment, Modularity Concept and Life Cycle Assessment Toward Sustainable Product Design", MATEC Web of Conferences V.159,PP. 02070 (2018).
- [8] George E. Dieter, Linda C. Schmidt; "Engineering Design, Fifth Edition", The McGraw-Hill Companies, 2013.
- [9] Chun-Yu Tung; "A green product design framework based on quality function deployment process", thesis, University of Windsor, 1999.
- [10] Kai-Jung Chen, Tsu-Ming Yeh; "Integrating Refined Kano Model and QFD for Service Quality Improvement in Healthy Fast-Food Chain Restaurants"; National Changhua University of Education, 2018.
- [11] Lance B. Coleman; "The Customer-Driven Organization", CRC Press is an imprint of the Taylor & Francis Group, an informa business Boca Raton London New York, a productivity press book, 2014.
- [12] Osama Malik Mohammed; "Design for X in Concurrent Engineering Environment", University of Technology, Department of Production, Engineering and Metallurgy, 2014.
- [13] Sumit Chandak, Amit Chandak, Sunil Pipleya, Vinay Dubey, Anubhav Yadav; "Study of a Pump Less Air Cooler", Shri Vaishnav Institute of

Technology and Science, Indore (MP), India, IJARIE-ISSN(O), Vol-2 Issue-3, pp. (2395-4396), 2016.

- [14] Samir B.Salman Al-Badri and Faiz F.M. AL-Makhul; “Study the Effect of Add Secondary Water Pump to Air Cooler Type Bf3 on the Efficiency of Air”, Dept. of Agric. Mechanization/ College of Agriculture/ University of Baghdad, Dept. of Agric. Mechanization/ College of Agriculture/ University of Baghdad, Elixir Agriculture 96, 41211-41213, 2016.
- [15] Khalil I. Mahmoud, Zainab K. Hantoosh and Muslih Abdullah”; “Practical Application For

Designing Quality House”, Eng.and Tech. Journal ,Vol.28, No.16, 2010.

- [16] Yizhou He; “Energy Saving of Central Air-Conditioning and Control System Caseb Study: Nanchang Hongkelong Supermarket”, Master Thesis, Savonia University of Applied Sciences, Business And Engineering, Varkaus, (2010).
- [17] Ahmed Abul Redhah; :Modeling a Framework for Baghdad Petroleum Product’s Consumption”, Thesis, University of Technology, Industrial Engineering, 2017.