

The light emitted by the LED is detected by the photodetector, which in turn converts the invisible high-frequency light into an electrical signal. At the present time, energy is considered one of the most important things because its shortage constitutes a major obstacle to the development of civilization and causes a shortage of food, warm housing and internet connections. One of the important things is the use of modern and advanced technologies to produce large quantities of energy to maintain and improve the standard of living. Since the discovery by the scientist Baker but in 1839 the first light effect, solar energy has become an important goal in the scientific world, so the design of efficient and effective solar cells has become an important matter so as not to be relying on fossil fuels only. There are many advantages and benefits of photovoltaic technology. These cells are small in size and can be found in any location, clean and safe, compared to other technologies for generating electricity such as plants that depend on oil, gas, nuclear and coal. This solar photovoltaic energy does not require a high cost of maintenance, operation and fuel, but it continues to produce energy as long as the sun shines. In order for the solar cells to be effective, they must work in accordance with the solar spectrum range, which ranges between (100nm _ 1 nm). It is noted that most of the radiation occurs between (250nm 2500nm) as shown in the Fig.(1) and with the maximum visible region of light (400-700 nm) for the air mass That is, solar cells try as much as possible to absorb the largest amount of the solar spectrum in the visible part. The air mass is the ratio between the length of the path of light in the atmosphere to the shortest path length ,when the sun is perpendicular to the head [1]-[3].

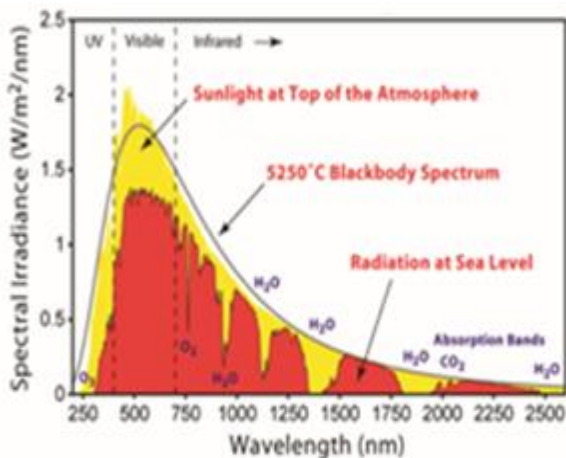

Figure 1. Solar Radiation Spectrum

A solar or photovoltaic cell is a device that converts light directly into electricity depending on the photoelectric effect, and this device affects its electrical properties when exposed to light

such as voltage, resistance and current, and it is noted that a single-junction silicon cell can produce a voltage of (0.5 - 0.6) volts. These solar cells can be used as light detectors, such as infrared detectors, and they can detect any electromagnetic radiation close to the visible beam, as well as measure the intensity of light. The work of the solar cell requires three things, firstly, absorbing the incident light and generating a pair of holes and electrons, and secondly separating the charge carriers from the opposite types and thirdly the output of heat waves to an external circuit, Fig. (2) shows the equivalent electrical circuit of solar cell (DC) [2] [4].

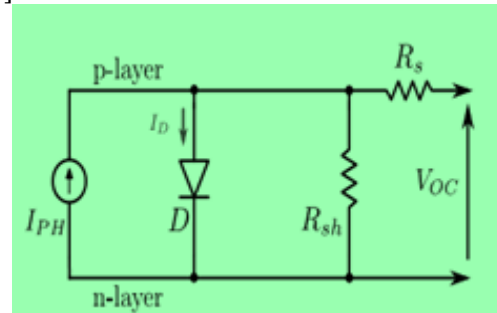

Figure 2. The equivalent circuit of Solar cell

The need for independent wireless communication systems led to the manufacture of integrated products. In satellite and vehicle communication systems, having an independent power source from the network is important, and this is achieved using photovoltaic technology, which is characterized by high reliability in addition to its longevity. In addition to the need for the presence of antennas to send and receive electromagnetic signals. We notice that there is competition between the antenna and the solar cell for space in the independent and portable systems, which are of limited size. To overcome this problem, it is preferable to combine the solar cell and the antenna in the device, and thus the design cost of these devices can be reduced. At the Institute of Solar Energy Supply Technology, a solar cell integration device was invented. And the antenna in an integrated unit as shown in the Fig. (3). And "Solar Planar Antenna - SOLPLANT" has provided us with many applications in wireless and mobile communication systems that exploit the simultaneous presence of the antenna with the solar cell at a low cost [5][6].

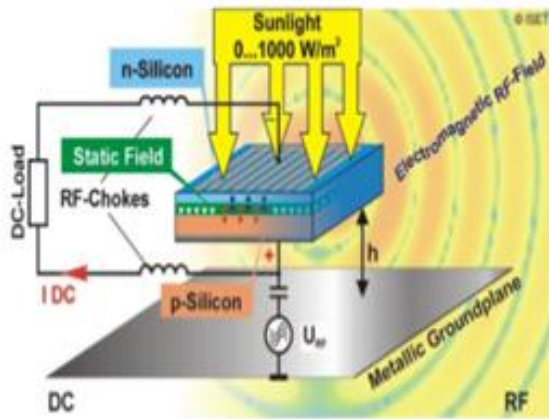

Figure 3. SOLPLANT ,radiation of electromagnetic waves and DC current generation at same time

Power generators are important for spacecraft, and the demand for energy faces many obstacles, including the size of the generation system and times of the eclipse, in addition to the energy density. In the medium term, we notice the need for high levels of energy for platforms orbiting the Earth, and the vehicles face the obstacle of distance from the sun . The Moon and other planets such as Mars have large infrastructures and have a weak environment and long eclipse periods, all of this led to the need to design and manufacture technologies and systems to overcome these problems. The SPS solar satellites, which depend on wireless energy transmission, are considered one of the most important solutions that Provides energy for spacecraft . Energy is fed to the spacecraft by the solar system. This solar system consists of two identical wings extending from the southern and northern sides of the satellite, as shown in the Fig. (4) , Energy is fed to the spacecraft by the solar system. This solar system consists of two identical wings extending from the southern and northern sides of the satellite, as shown in the figure 4.

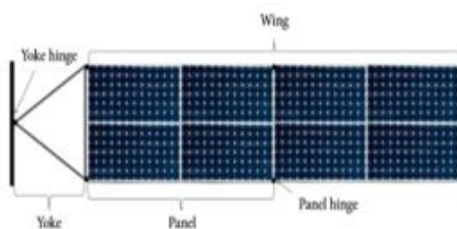

Figure 4. Deployed wing of solar array

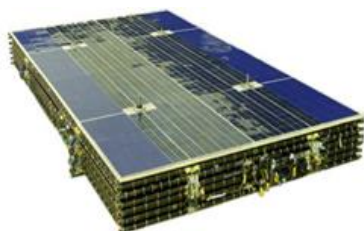

Figure 5. Stowed wing of the solar array

Each wing includes a yoke and two panels connected by joints with closed cable loops. As for the Fig. (5) , the wings are hidden in the side walls of the spacecraft by the suspension mechanism, and when launched, they are deflated. When the spacecraft is launched, the screws fixing the spacecraft are cut off and the solar array is deployed [6] [7][8].

The Fig. (6) is a semiconductor solar cell structure consisting of a PN junction with metal front and back electrodes. The Fig. (7) shows the PN junction and the depletion region [8 [9] , This article aims to review the most important modern applications that combine communication systems and solar cells and to know the most important advantages of these applications.

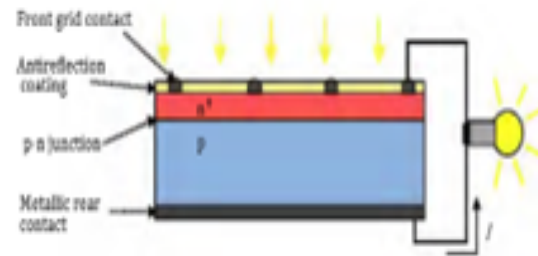

Figure 6.: Solar cell structure

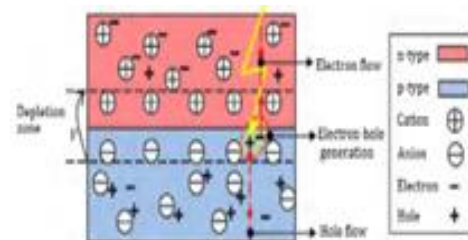

Figure.7 :P-N junction

2.Solar Cells Technologies

Solar cells are classified into a number of generations, the cells in the **first generation** are made of crystalline silicon, such as monocrystalline silicon or multi-silicon, and it is known as the generation of conventional cells, This generation was presented in 1954 by Chaplin, Fuller and Pearson. It uses silicon for its low cost of manufacture despite its low efficiency, and there are also things that affect the cost such as crystal growth and the need for cells to be packaged to be placed in place. We note that a thickness of 100 μm is required to absorb 90% in silicon and a thickness of 1 μm is required to absorb the same value in GaAs, and there are techniques for manufacturing a silicon tape to reduce the manufacturing cost.

The **second generation** consists of thin cells such as amorphous silicon cells, This generation appeared in the seventies and uses triple compound semiconductors, in which cells need what is needed ($\sim 10 \mu\text{m}$) to absorb light . While the **third generation** consists of multi-junction solar cells that are mainly used in space applications, gallium arsenide (GaAs), which is a semiconductor compound, was used instead of silicon and in various forms. Experiments showed that multi-junction gallium solar cells with GaAs have an efficiency of 31.6%, and from The important advantages of GaAs is that it has a bandgap of 1.42eV which is close to the ideal value suitable for PV applications and has high performance at high temperatures. In addition to the **next generation** cells , this generation includes organoid cells, pigment-sensitive cells, quantum dot cells, and kesterite cells [1]-[3],[10]-[12].

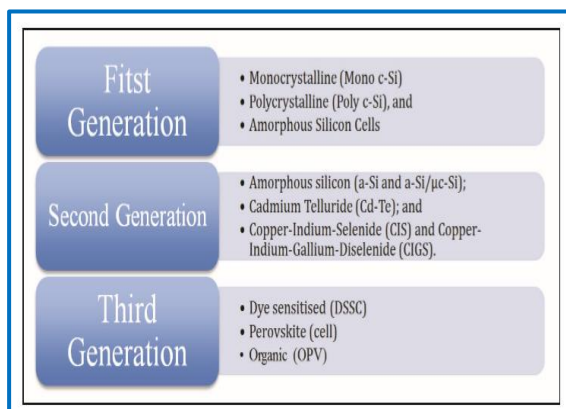

Figure 8. Classification of PV cells

3. Systems integration

The spread of photovoltaic systems tremendously in the electrical distribution networks, so it faced many challenges and problems such as voltage regulation and reverse energy flow. Therefore, research sought to further improve the reliability of the system in general. Therefore, the integrated system includes the following :

3.1 Network reliability and performance: To obtain a high level of distribution in the transmission network, i.e. less than 69 kV, we need to improve the analysis and simulation processes to address the problems facing the network and its reliability [13][14].

3.2 Transmission: In order to improve the transmission capacity of photovoltaic stations to be better than traditional stations, focused analyzes must first be conducted to find out the reason for the high penetration of solar energy in distribution and bulk energy operations .Secondly, the transmission capacity of photovoltaic stations must be strengthened and the value of energy storage known, which in turn

leads to a decrease in storage prices [13][14]

3.3 Power electronics: They are smart devices that have the ability to increase energy productivity through photovoltaic arrays. The power electronics must balance the basic design factors, which are performance, that is, improving efficiency and reducing the cost of the devices used while maintaining the high reliability of the system [13][14]

3.4 Communications: It is necessary to have modern and advanced communication and information technologies with sensors to follow up the management of the network and solar energy technologies through it, because we need multiple spatial scales (ie the user load in the distribution substation and the next) and multiple time scales (from microseconds to hours and days), and that the use of Communication protocols in these organizations and inverters increase the integration of the system and help increase the growth of solar energy systems [13][14]

4. Li-Fi Technology

Li-Fi This technology is considered one of the modern technologies for short-range wireless systems and relies on LED lamps to transmit information, that is, they are visual optical communications (VLC) that operate at very high speeds. Professor Harald Haas of the University of Edinburgh is the one who formulated Li-Fi in 2011, where he hypothesized that light bulbs could be wireless routers, that the transmission of data in Li-Fi would be via LEDs and then transmitted to photoreceptors or solar cells, although light is used in Optical cables are already available, but Li-Fi technology is one of the new technologies that can be adopted in global communications in high-speed Internet networks. The first Li-Fi system consists of a light-emitting diode (LED), which is a device made of a semiconductor material that emits light when an electric current passes through it, as shown in Fig. (9) , and this light is clear and bright. Old LED lamps produce only red color, but modern ones can produce different colors such as green and blue light And red and white light too . Secondly, the Li-Fi system consists of a photodiode that converts light into an electric current, as shown in the Fig. (10), which is a semiconductor p-n link. These photodiodes are used in electronics, detectors, and in large-scale optical communications. Third, the Li-Fi system contains an image sensor as shown in Fig. (11) , which in turn converts an optical image into an electrical signal, and these sensors are used in cameras and imaging devices [2][14]



Figure 9. The LEDs

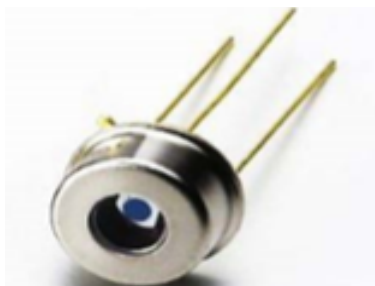

Figure 10.: The Photodiode



Figure 11. The Image Sensor

5.Solar Power Satellite Technology

The technology of placing large-sized satellites operating on solar energy in space is one of the modern technologies that provide us with clean and large-scale energy. This technology was examined in America in the seventies, and NASA re-examined the subject in the period 1995-1997, and continued research on this subject, This system includes three main parts [6][15]:

- 1.Reflectors or mirrors collect solar energy from space.
2. Wireless energy transmission by laser or microwave to the ground.
3. Receive energy on the ground through the microwave antenna.

Solar-powered satellites revolve around the Earth. These satellites are designed to absorb and transmit solar energy to the satellites on the ground, thousands of miles away. The simplest types of these satellites include a large number of solar cells, which in turn dissolve sunlight into an electric current, with an inner core that converts the electricity into microwaves similar to a

mobile phone that are received by the antennas on the ground. The antennas in the network on the ground convert the microwave waves into continuous electric waves again.

6. Modern Applications of Solar Cells in Communication Systems:

C. Bendel, J. Kirchof, and N. Henze (2004) , This research includes a description of the application of solar photovoltaic cells in the planar antenna, and the radiating element of the antenna is replaced by a solar cell. The solar cell can transmit and receive electromagnetic signals in addition to generating direct current and can be used as antennas, whether it is a single solar cell or an array of cells. SOLPLANT (Solar Planar Antenna) has wide applications in wireless, mobile and Bluetooth systems as well as in satellite[5]. S. Zhang et al (2015) In this paper, it was shown that solar cells that are used in portable devices can extract data at high speeds in optical wireless communications in addition to generating energy at the same time. This paper also demonstrates the use of an energy harvesting receiver for Visible Light Communication (VLC) consisting of an organic solar cell. This communication link gives a data rate of 34.2 Mbps with a BER of 4.08×10^{-4} with OFDM adaptation, and the solar cell gives the greatest generated power of 0.43 mW with an effective area of 8 mm². It has been shown that using the VLC of the organic solar cell as a receiver works Without external bias and be able to harvest power and data communication at the same time . The table (1) represents a summary of the data rates and the power generated for several values of the load resistance RL , and the Fig. (12) represents the equivalent circuit of a solar cell to collect communications and harvest energy [8].

Table (1) :A summary of the data rates and the power generated for several values of the load resistance RL

R_L [Ω]	Data-rate [Mbps]	BER	P_t [mW] commun. branch connected	P_t [mW] commun. branch open
200	423	1.10E-3	0.19	0.19
400	378	7.00E-4	0.30	0.34
600	342	4.08E-4	0.43	0.44
800	268	6.37E-4	0.41	0.43
1k	264	7.78E-4	0.38	0.41
2k	223	1.23E-3	0.24	0.25
5k	213	1.59E-3	0.11	0.11

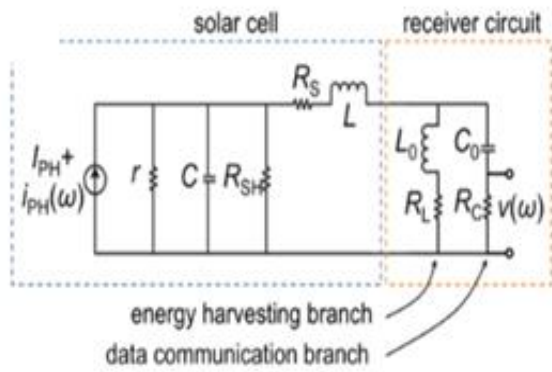

Figure 12: Solar cell model

R. Shubham (2016) , This paper presents an illustration of the technology of solar energy satellites, where the solar cells in the satellite convert sunlight into an electrical signal, which is converted into radio frequencies in the receiver located on the ground and then converted back into electricity using the antenna with wireless energy transmission technology (transmission of Energy as a microwave to eliminate distribution and transmission losses), as photovoltaic technologies have developed amazingly, which led to an increase in the efficiency of solar cells based on crystalline silicon [16]. F. J. T. Salazar and O. C. Winter (2017), In this paper, a Solar Satellite System (SPS) was presented. The Microwave Transmitting Satellite MTS is placed on a fixed orbit relative to the Earth in the equatorial plane. Assuming that the position of the sun is on the plane of its path with an average slope of = 23.5 degrees, and the law of reflection was adopted in the reflection attitude . It was also noted that there is an effect of solar turbulence on the (SPS) synchronization, which leads to an increase in longitude and differences in the angle of inclination of the reflector [17]. A. S. Kumar and S. Sundaravadivelu (2017) This research suggests

a combination between Microstrip antenna and solar cell called Solan. This combination is designed by RF and visual. The hybrid silver is used from Indium tin oxide (ITOS) that generate electrical signals of streams and RF signs when sending and receiving . Where the reflection, earning, energy and directional coefficient of (ITOS) was drawn and directed. The research showed that ITOS has a high reflection factor and high radiation that compares to (AGHT), the antenna work was analyzed by parameter studies to clarify current, radiation and resistance. The proposed method depends on the system that generates a continuous current when the light falls on the ITOS surface and generates the RF signal with the fall of the ITOS, to obtain the results the ADS program has been adopted. The ITOS solar cell antenna can be considered a platform for many communication applications and also can be adopted as a sender and a future wireless frequency in addition to generating the DC stream [18]. Y . Perwej (2017) This paper aims to explain Li-Fi technology and its working principle, which is a wireless system in which the light signal is used as a carrier signal as an alternative to the traditional radio frequencies used in Wi-Fi. In Li-Fi technology, a LED is used to transmit data. The data transfer speed in this technology is faster than 10 Mbps, which is greater than the speed of LAN. Li-Fi technology is superior to Wi-Fi technology because of its use of VLC, which It can exploit a spectrum of up to 60 GHz. The use of Li-Fi in communication systems makes it more secure and better, and it is a thousand times faster than Wi-Fi technology. The table (2) shows a comparison of the most important communication technologies used to transfer data.

Table (2) : A comparison of Li-Fi , Wi-Fi ,WiMAX and Bluetooth [14] .

Features	Li-Fi	Wi-Fi	WiMAX	Bluetooth
Full form	Li-Fi (Light-Fidelity)	Wi-Fi (Wireless- Fidelity)	WiMAX (World wide Interoperability for Microwave Access)	Bluetooth Full form the epithet of the tenth-century king Harald " Bluetooth " Gormsson .
Operation	Li-Fi transmits data by means of light and with the help of LEDs	Wi-Fi transmits data by radio waves and with the help of router	Broadband Wireless Access	In any place where there are at least two Bluetooth devices.

Interference	There are no interference problems as in radio frequency waves	There are interference problems in nearby access (points (routers)	WiMAX communications interfere with satellite waves at the C band .	Bluetooth devices that interfere with other technologies
Technology	IrDA compatible devices	WLAN802.11a/b/g/n/ac/ad Compatible Devices	WMAN	WPAN
Applications	It is used in marine exploration, in the airline, in hospitals, in operating rooms and home buildings, to transmit information, the Internet, and offices.	It is used in the Internet for browsing with the help of Wi-Fi access points and kiosks .	WiMAX serves a larger interoperable network .	Bluetooth has enormous applications because we deal with business and communicate with people who are near more than far away .
Merits	It passes through the salt water of the sea and can work in the dense area and has less interference.	It does not pass through salty sea water, operates in a less dense area, has more interference.	WiMAX is used in long ranges, and provides us with broadband connections up to variable ranges, up to 30 km.	The Bluetooth connection between two devices is easy and fast. The Bluetooth headset is compatible with any Bluetooth-enabled device .
Privacy	In Li-Fi technology, data transmission is more secure and safe because light is blocked by walls.	In WiFi, we need other technologies to have a secure transmission of information, because the wireless signal is not blocked by the walls .	WiMAX uses X.509 or PKMv2 companion algorithms , Mandatory - 3DES Optional - AES	Bluetooth technology has a lot of safety modes, and manufacturers are the ones who determine the mode used in a smart device that supports Bluetooth
Data transfer speed	Around 1 Gbps	WLAN-11n gives a speed of 150 Mbps, and about 1-2 Gbps is achieved using WiGig / GigaR	It operates at 5bps /Hz and can go up to 100Mbps in the 20MHz channel	800 kBps
Frequency of operation	10 thousand times of radio frequency spectrum	2.4 GHz ,4.9 GHz and 5 GHz	Licensed /Unlicensed 2 GHz -11 GHz	2.4 GHz
Data density	Working in a high density environment	working in a less density environment due to interference	Working in a high density environment	Less density
Coverage distance	About 10 meter	About 32 meter (WLAN802.11b/11g/) , The value varies depending on the type of antenna and the transmitter power	Up to 40 miles	About 10 meter
System components	The complete LiFi system includes the lamp driver, LED lamp and photo detector	Router installation requires subscriber devices (laptops, PDAs, and desktops)	The WiMax architecture consists of basic components, first the mobile stations, second the access service network, and third the communication service network that provides IP functions .	It contains four components: first, the radio unit (a wireless transmitter and receiver), secondly the baseband (a flash & CPU unit), thirdly the driver software , and fourthly the application (user interface) software
Power consumption	Medium	Medium	High	Low
Cost price	Low	Medium	Medium	Low
Working Concept	Direct Binary Data Servng	Various Topologies	Request /Grant	Master/Slave

C. Baccouch et al (2019), In this research, a hybrid solar cell antenna suitable for 5G mobile communications is proposed. This antenna combines radio and optical signals. Two antenna structures are designed in the 2.6 and 3.5 GHz bands. The advanced antenna design system (ADS) design software was used, which enables the analysis and determination of the proposed antenna parameters such as gain, directivity, reflection coefficient (S11) and radiated power. The proposed antenna is a printed solar cell antenna with a multi-layered substrate as shown in Fig. (13). The layers are lattice The anode, silicon and cathode, the anode is made of silver and the cathode is made of aluminum, while the silicon is based on a SiO₂ insulating layer, it gives the ability to work at low voltage, high working frequency, low energy consumption and insensitivity to ionizing radiation [19].

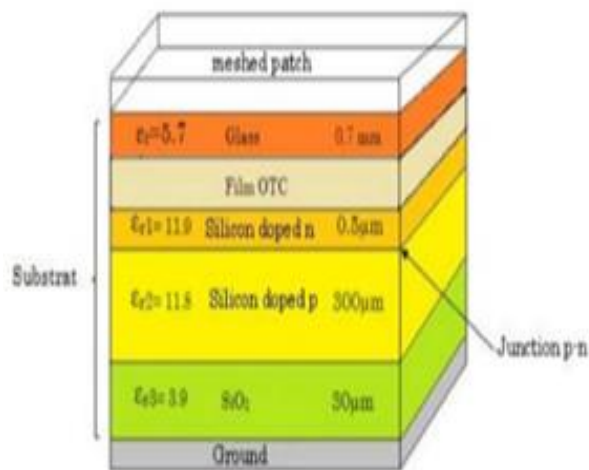

Figure 13. Multi-layered substrate of solar cell antenna.

N. Lorriere et al (2020) , This paper proposes a comparison of the behavior of a typical commercial APD-based photo detector to carry out an experimental process of LiFi transmission in outdoor and indoor conditions. Performance parameters were measured , in different frequency responses, such as measuring the signal-to-noise ratio, measuring the attenuation value, and the bit error rate. The results showed that the photodiode performs very well in indoor conditions, but when exposed to more than 200 W/m² of sunlight above the LiFi signal, its frequency response rapidly deteriorates. From the Fig. (14) it is clear that the APD approved photo detector has a breakdown at a solar energy level approaching the value of 200W / m², while the photovoltaic unit allows LiFi

communications despite its exposure to full sunlight [2].

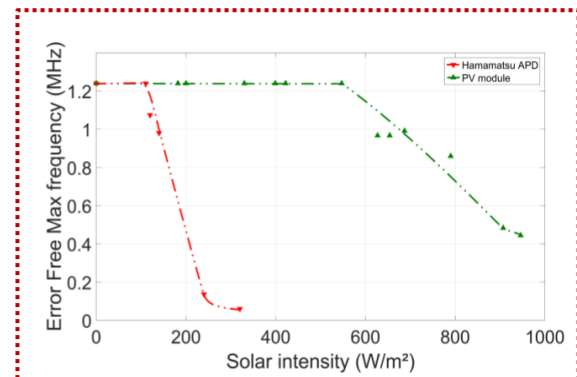

Figure 14. Comparison of error free Fmax between PV model and APD .

S. Oukil and A. Boudjemai (2020), This paper presented a solar array design for a geosynchronous communications satellite depending on performance and power requirements. The number of panels, cells and strings used in the solar array was also determined. The study focused on optimizing the energy generated from the satellite's solar array with the extraction of photovoltaic module parameters. A gravity search algorithm based on group interactions and the law of gravity was used. This algorithm has proven its efficiency in developing system parameters. One of the most important results obtained in this research is the reduction of the total energy in the system 181 Watt, which is approximately (8.20% of the total energy), in addition to calculating the amount of energy produced in solar panels at different temperatures and calculating the degradation values. The paper also showed that the GSA (gravitational search algorithm) is close to the optimal design [7]. Y. Naga, S. Vamsi, and A. S. Raja (2021), This paper reviewed several optical wireless communications (OWC) receivers, which are considered as an alternative solution to solve the problem of wireless spectrum congestion, as different types of receivers can be used, such as the receiver that depends on Photodiode and the receiver that depends on solar cells in addition to the receiver that depends on the image sensor These systems work with the help of different sources such as visible light (VL), ultraviolet (UV) and infrared (IR). The paper explained that photodiode-based receptors achieve high-speed detection, while image sensor-based receptors provide a high SNR rate. But receivers based on solar cells combine

energy capture and communication at the same time, and they achieve good performance in data rate and transmission distance. As shown in table 3

Table 3: Comparison of Receivers for optical wireless communication [20]

Paper Referre d	Receiver Type	Observations
Hoa Le Minh et al [21]	Photodiode-based	The VLC receiver includes a focusing lens with a blue filter with photo detector (PIN type) in addition to a Transient Impedance Amplifier (TIA) with the use of a filter to eliminate unwanted spectrum.
Yuki Goto et al [22]	Camera / Image sensor – based	The image sensor-based receiver spatially separates the light sources, achieving high SNR and low communication interference.
Masayuki Kinoshita Et al [23]	Camera/ Image sensor – based	The image sensor has the ability to separate many light sources, which adds an effective feature to VLC, and it can be used as a receiver in VLC or the so-called image sensor-based VLC, also known as OCC (Optical Camera Communications). This receiver uses the pixels attached to the image sensor and leaves the rest of the pixels, including the noise-detecting ones. This receiver is a good and efficient solution for external applications in OWC, including those that detect noise. Image sensor based VLC is an efficient solution for OWC outdoor applications .
Yang Liu et al [24]	Solar Cell-based	The high capacity of the solar cell causes a limitation on the time of the detected signal in terms of rise and fall. Even at a low level of illumination of 100 lux, the solar cells are very suitable for receiving the signal of the downlink.
Z. Wang et al [25]	Solar Cell-based	In solar panels, there is no need for an additional transducer that converts the light into an electrical signal. OWC, which uses a receiver based on solar cells, can simultaneously combine energy harvesting and communications.
Shuyu Zhang et al [8]	Solar Cell-based	The simultaneous combination of achieving energy harvesting and communication is of great importance in the communication of smart devices,

		and these devices have become an essential part of the "Internet of Things ".
Bilal Malik et al [26]	Solar Cell-based	A VLC receiver based on solar cells uses a signal conditioning unit to treat the deterioration of the input signal at the output of the solar panel. The solar cell is a photo detector. The return of the electrical signal sent by the visible light is the main goal. The receiver circuit has the ability to convert the optical signal into an electrical signal .
Won-Ho Shin et al [27]	Solar Cell-based	The receiving circuit used is self-biased in order to improve data communication and power capture in addition to improving response and response time.
Rohail Sarwar et al [28]	Solar Cell-based	The solar cell is an passive component. This cell uses a photo detector while capturing energy at the same time. It can convert light into an electrical signal. This energy is generated to operate the user's stations.
Hung-Yu Chen et al [29]	Solar Cell-based	The cost of the solar cell is low, as it has the ability to convert an optical signal into an electrical signal without the presence of an external power source. A data rate of 0.4 Mbit/s at a BER of 10^{-9} was achieved at a transmission distance of 75 cm, and a data rate of 0.3 Mbit/s at a BER of 10^{-9} was achieved at a transmission distance of 125 cm, by using the solar cell as an optical Rx for VLC .

H. Seo and J. Suh (2021) , In this study 100 applications that combine smart phones and solar photovoltaic cells were examined, and these applications were classified according to their main functions. The limitations facing these applications were also discussed. This study clarified the application capabilities of smart photovoltaic phones, and demonstrated the possibility of using them effectively as an analysis tool in energy design systems due to the sensors owned by the smart phone, these applications were studied from the point of view of cost, features, basic system and sensors. In this study, 100 applications that combine smart phones and solar photovoltaic cells were examined, and these applications were classified according to their main functions. The limitations facing these applications were also discussed. This study clarified the application

capabilities of smart photovoltaic phones, and demonstrated the possibility of using them effectively as an analysis tool in energy design systems due to the sensors owned by the smart phone. These applications were studied from the point of view of cost, features, basic system and sensors. The percentage of free apps was 74% and the paid apps were 26%, with the most expensive app costing \$31.00. This study summarized the applications of photovoltaic smartphones on surfaces by extracting their properties such as shape, inclination, direction, etc. by remote sensing by means of precise satellite imaging. And also in economic applications and environmental impacts, and applications of games for its importance in learning and education. The study also showed the importance of sensors and their applications related to solar energy, and there are different types of sensors (GPS, image sensor, accelerometer, gyroscope, magnetometer) [30].

M. Bekhti (2021), In this work, a methodology was explained for the system-level design of solar cell arrays for a geographically fixed mini satellite with a power of 2 kw [31].

W. An, H. Wang, and Y. Luo (2021), In this work, a dual-band single port antenna is proposed, integrated with solar cells, compatible with a 2.4/5 GHz WLAN. 30 solar cells were integrated into the antenna to collect energy and communications, micro strip antennas were adopted in the structure and using multiple modes of resonance in the dual band as shown in Fig. (15). The results of the research showed that the lower band ranges (2.27 GHz - 2.5 GHz), while the upper band ranges (4.8 GHz - 6.9 GHz) in future low carbon communication systems. As the paper clarified, the shape of the radiation pattern for the lower band is omnidirectional, which is suitable for the reception process, while the shape of the radiation pattern for the upper band is unidirectional, which is suitable for the transmission process [32].

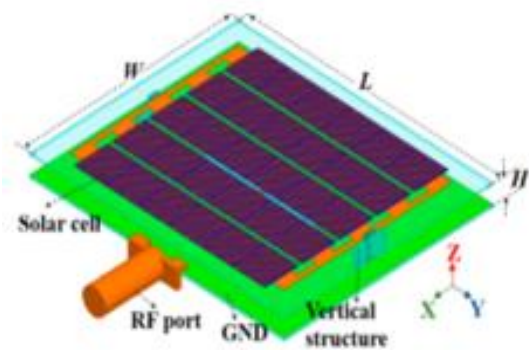

Figure 15. The proposed dual band solar cell antenna .

S. B. Thandullu Naganathan and S. Dhandapani (2021), This article presented a survey and a detailed study of the modern techniques of patch antennas integrated with solar cells, look at the Fig. (16). where this paper showed a discussion of the four types of antenna units integrated with solar cells. Improvements were made to antenna features such as antenna dimensions, substrate selection, gain, operating frequency, radiation characteristics, impedance beam width, polarization, and maximum power of solar cells. The integration of the solar cell with the antenna is appropriate in wireless communications and this product is effective in terms of size, cost and energy harvesting [33].

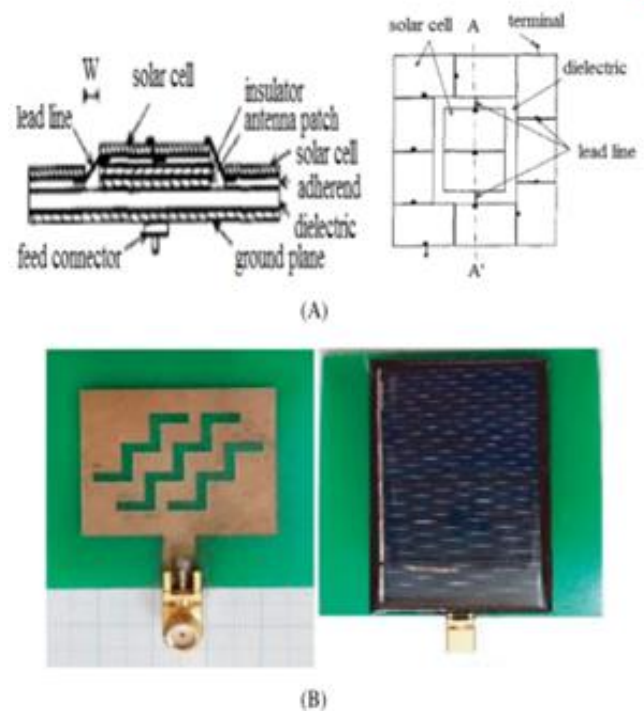

Figure 16: configuration of integrated of sub solar antenna.

A. Ali et al (2021), In this research, an integrated antenna was presented with solar cells as shown in Fig. (17), the cell is made of indium gallium and has a high form factor, and the results showed that the integrated antenna covers the entire scientific-medical-industrial frequency range from 2.4 to 2.5 GHz and achieves a gain of 2.79 dB with a beam efficiency of up to higher than 80%. The regression structure of the design reached $0.0046 \lambda_0$, with λ_0 representing the wavelength in space at 2.45 GHz

with a form factor ratio of 99.1%. Which are suitable for building a smart environment in a large-scale deployment of wireless sensor systems WSNs and the Internet of Things to increase their efficiency and operational life [34].

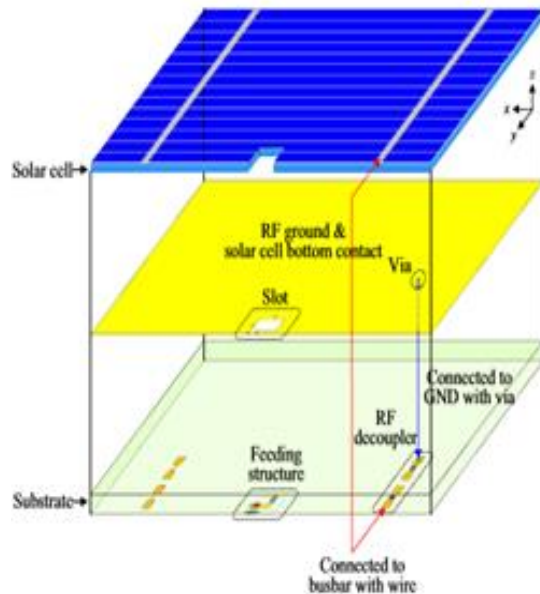

Figure 17. Geometry of solar cell integrated antenna.

G. A. Urdaneta, C. Meyers, and L. Rogalski (2022), In this paper, the ability and challenges associated with the use of satellites that rely on solar energy were clarified, in addition to clarifying the mechanisms used to transmit microwaves, the effect of radiation and photoelectric assembly. The disadvantages and benefits of satellites based on solar cells were also discussed, as it was found that the efficiency of energy collection exceeds 30% when using photovoltaic cells manufactured from Gallium Arsenide, and the possibility of reducing the radiation effect by using Pilkington Borosilicate transparent glass with a capacity of 100 microns. The preferred frequencies for energy transmission range from 2.4 GHz to 6 GHz. The paper also indicated that the launch cost of GEO should be reduced by a factor of 10, and the efficiency of solar panels should be increased to 40%, in addition to reducing the density of panels while achieving international cooperation[35].

M. H. Alsharif et al (2022), The main objective of this study is to achieve the best size and economic technology for the solar photovoltaic system to expand the mobile cellular technology in a

sustainable and clean manner. The simulation was done to find out the optimum size, cost and performance of the energy system. In the study, the researchers used long-term meteorological data with latitude (30° 06'N) and longitude (31° 25'E). Greenhouse gases, which in turn support green wireless networks (WN) in remote areas. The Fig. (18) shows the architecture of proposed hybrid energy system[36].

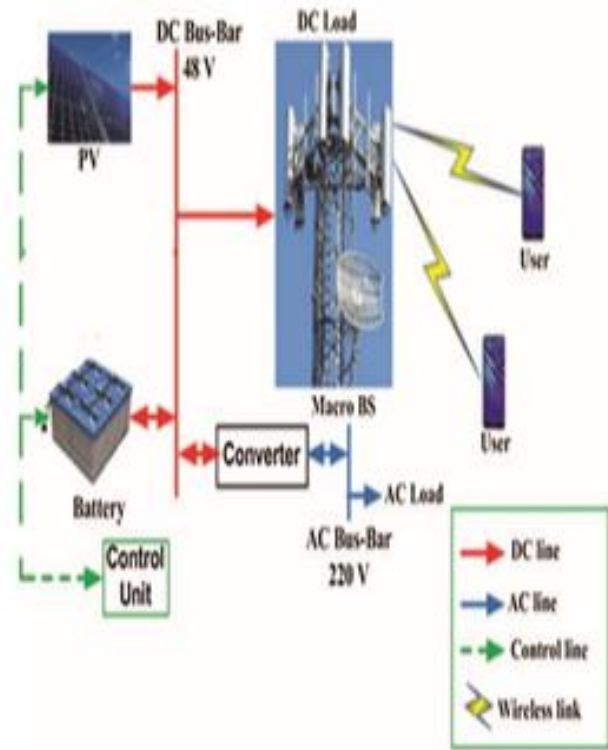

Figure 18. Architecture of hybrid energy system.

F. M. E. Haroun et al (2022), In this paper, a wireless sensor transmitter unit (WSTx) without battery and low energy was developed, based on LoRa technology and solar energy harvesting using polycrystalline photovoltaic cells with a maximum power of 1.4 MW. The power consumption value of WSTx was equal to 0.02109 when idle and equal to 11.1 MW when operating. And the value of the energy harvest of the system up to 1.2 megawatts per second. The energy harvested has the ability to run the WSTx for six hours with an energy efficiency of 85.714%. The Fig. (19) shows the proposed ultra-low- power WSTx system of this paper[37].

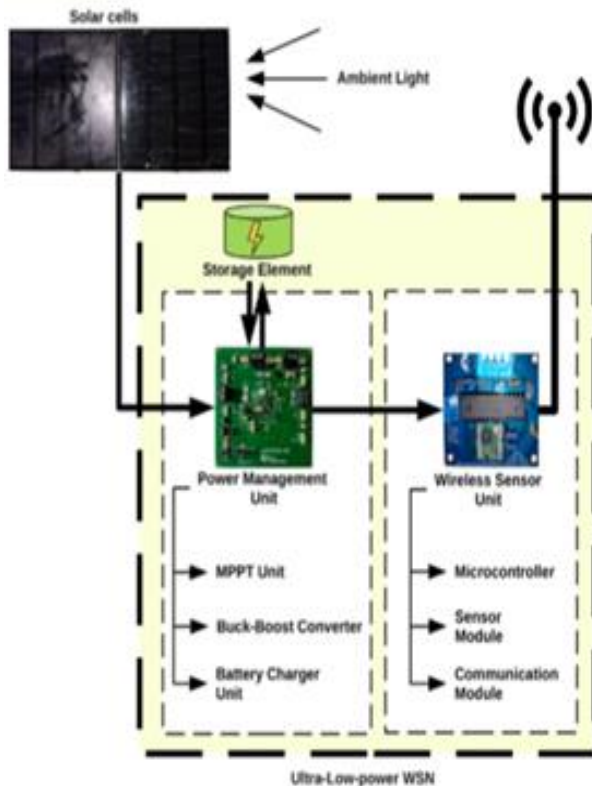

Figure 19. The proposed ultra-low- power WSTx system .

Conclusion

The rapid development in communications technology and the congestion of the radio spectrum for wireless communications made photovoltaic solar cells an important and complementary part of these systems, due to the excellent advantages of these cells such as their small size and cleanliness, and they are safer than other technologies, which made optical communications a good alternative to wireless communications. In this paper, the most important techniques were presented and clarified and the recent applications of solar cells in communication systems such as Li-Fi technology, which is one of the modern technologies adopted by global communications systems and high-speed Internet networks, where Li-Fi consists of a light-emitting diode (LED) and a photodiode in addition to an image sensor. The satellite technology that relies on solar cells, which is one of the modern technologies that provides us with clean energy and a wide range, was also presented, this technology consists of three main things, firstly, an array of solar reflectors or mirrors, secondly, energy transmission, by laser or microwaves, and finally energy receivers, found on the ground like a

microwave antenna. The most important things discussed in this paper can be summarized as follows:

1. An overview of the many researches and studies that dealt with modern applications of photovoltaic solar cells in communication systems.
2. Presentation and clarification of the most important conclusions reached by researchers in this field.
3. All research and studies agreed that solar cells are an integral part of communication systems and that the combination of energy harvesting and communication systems is important in smart communication devices as well as in the "Internet of Things".
4. Integration of the solar cell with the antenna is an effective product in communication systems in terms of cost, size and energy harvesting.
5. Research has shown that there is an improvement in data speed and energy capture, in addition to a decrease in the cost of the solar cell with high efficiency, which provides us with a promising future for safe, clean and efficient green communication systems.

References

- [1] M. Arun, "Types of Solar Cells and its Applications," *IJSDR1902043 Int. J. Sci. Dev. Res.*, vol. 4, no. 2, pp. 260-267, 2019, [Online]. Available: www.ijedr.org.
- [2] N. Lorriere *et al.*, "Photovoltaic Solar Cells for Outdoor LiFi Communications To cite this version : HAL Id : hal-02901381 Photovoltaic Solar Cells for Outdoor LiFi Communications," 2020.
- [3] K. Ranabhat, L. Patrikeev, A. A. evna Revina, K. Andrianov, V. Lapshinsky, and E. Sofronova, "An introduction to solar cell technology," *J. Appl. Eng. Sci.*, vol. 14, no. 4, pp. 481-491, 2016, doi: 10.5937/jaes14-10879.
- [4] M. Moaz Baig, "Solar cells and its applications," *Int. J. All Res. Educ. Sci. Methods*, vol. 9, no. 7, pp. 2455-6211, 2021.
- [5] C. Bendel, J. Kirchof, and N. Henze, "Solar Cell Antennas in Wireless Communication and Radio Broadcast," no. June, pp. 5-8, 2004.
- [6] C. Cougnet, E. Sein, A. Celeste, and L. Summerer, "Solar power satellites for space applications," *Int. Astronaut. Fed. - 55th Int.*

- Astronaut. Congr. 2004*, vol. 10, no. August 2006, pp. 6794–6801, 2004, doi: 10.2514/6.iac-04-r.3.09.
- [7] S. Oukil and A. Boudjemai, "Geostationary communication satellite solar array optimization using gravitation search algorithm," *J. Aerosp. Technol. Manag.*, vol. 12, no. 1, pp. 1–25, 2020, doi: 10.5028/jatm.v12.1165.
- [8] S. Zhang *et al.*, "Organic solar cells as high-speed data detectors for visible light communication," *Optica*, vol. 2, no. 7, p. 607, 2015, doi: 10.1364/optica.2.000607.
- [9] M. José, R. Ons, P. B. Norton, and S. J. McCormack, "Integration of Antennas and Solar Cells for Autonomous Communication Systems," no. September, 2010, doi: 10.21427/D7GC9R.
- [10] R. A. Deshpande, "Advances in Solar Cell Technology: An Overview," *J. Sci. Res.*, vol. 65, no. 02, pp. 72–75, 2021, doi: 10.37398/jsr.2021.650214.
- [11] A. Mohammad Bagher, "Types of Solar Cells and Application," *Am. J. Opt. Photonics*, vol. 3, no. 5, p. 94, 2015, doi: 10.11648/j.ajop.20150305.17.
- [12] M. Tawheed Kibria *et al.*, "A Review: Comparative studies on different generation solar cells technology" *Proc. 5th Int. Conf. Environ. Asp. Bangladesh*, pp. 51–53, 2014, [Online]. Available: <https://www.researchgate.net/publication/274195294>.
- [13] J. D. Spelling, "Solar Power Technologies Concentrated Solar Power," *Lect. KTH*, 2015.
- [14] Y. Perwej, "The Next Generation of Wireless Communication Using Li-Fi (Light Fidelity) Technology," *J. Comput. Networks*, vol. 4, no. 1, pp. 20–29, 2017, doi: 10.12691/jcn-4-1-3.
- [15] U. I. W. Group, "Report of the URSI Inter-Commission Working Group on SPS," *Group*, no. June, 2007.
- [16] R. Shubham "Wireless Power Transmission through Solar Power Satellite (S.P.S)," vol. 3, no. 3, pp. 27–31, 2016.
- [17] F. J. T. Salazar and O. C. Winter, "Solar Power Satellite system in formation on a common geostationary orbit," *J. Phys. Conf. Ser.*, vol. 911, no. 1, 2017, doi: 10.1088/1742-6596/911/1/012006.
- [18] A. S. Kumar and S. Sundaravadivelu, "Design of Solar Cell Antenna (SOLAN) Using Indium Tin Oxide Mixed with Silver," vol. 9, no. 4, pp. 216–220, 2017, doi: 10.5829/idosi.ajbas.2017.216.220.
- [19] C. Baccouch, C. Bahhar, H. Sakli, N. Sakli, and T. Aguil, "Design of a Compact Meshed Antennas for 5G Communication Systems," vol. 13, no. 11, pp. 721–725, 2019, [Online]. Available: https://www.researchgate.net/publication/339644197_Design-of-a-Compact-Meshed-Antennas-for-5G-Communication-Systems.
- [20] Y. Naga, S. Vamsi, and A. S. Raja, "A Survey on Solar Cell based receivers used for Optical Wireless A Survey on Solar Cell based receivers used for Optical Wireless Communication," no. May, pp. 32–36, 2021.
- [21] Le Minh H, O'Brien D, Faulkner G, Zeng L, Lee K, Jung D *et al.* "80 Mbit/s Visible Light Communications using pre-equalized white LED", In Proceedings of the 2008 34th European Conference on Optical Communication. Piscataway, NJ: IEEE. 2008. p. 1-2 <https://doi.org/10.1109/ECOC.2008.4729532>.
- [22] Y. Goto *et al.*, "A New Automotive VLC System Using Optical Communication Image Sensor," *IEEE Photonics J.*, vol. 8, no. 3, pp. 1–17, 2016, doi: 10.1109/JPHOT.2016.2555582.
- [23] M. Kinoshita *et al.*, "Motion modeling of mobile transmitter for image sensor based I2V- VLC, V2I-VLC, and V2V-VLC," *2014 IEEE Globecom Workshops (GC Wkshps)*, 2014, pp. 450–455, doi: 10.1109/GLOCOMW.2014.7063473.
- [24] Y. Liu, H. Y. Chen, K. Liang, C. W. Hsu, C. W. Chow, and C. H. Yeh, "Visible Light Communication Using Receivers of Camera Image Sensor and Solar Cell," *IEEE Photonics J.*, vol. 8, no. 1, pp. 1–7, 2016, doi: 10.1109/JPHOT.2015.2507364.
- [25] Z. Wang, D. Tsonev, S. Videv and H. Haas, "Towards self-powered solar panel receiver for optical wireless communication," *2014 IEEE International Conference on Communications (ICC)*, 2014, pp. 3348–3353, doi: 10.1109/ICC.2014.6883838.
- [26] B. Malik and X. Zhang, "Solar panel receiver system implementation for visible light communication," 2015 IEEE International Conference on Electronics, Circuits, and Systems (ICECS), 2015, pp. 502–503, doi: 10.1109/ICECS.2015.7440361.
- [27] Shin WH, Yang SH, Kwon DH, Han SK. "Self-

- reverse-biased solar panel optical receiver for simultaneous visible light communication and energy harvesting". *Optics Express*. 2016 Oct 31;24(22):A1300-1305. <https://doi.org/10.1364/OE.24.0A1300>.
- [28] R. Sarwar et al., "Visible light communication using a solar-panel receiver," 2017 16th International Conference on Optical Communications and Networks (ICOON), 2017, pp. 1-3, doi: 10.1109/ICOON.2017.8121577.
- [29] H.Chen , K Liang, C .Chen , S .Chen , C. Chow , C .Yeh , "Passive optical receiver for visible light communication (VLC)," InTENCON 2015-2015 IEEE Region 10 Conference 2015 Nov 1 (pp. 1-2). doi: 10.1109/TENCON.2015.7372787.
- [30] H. Seo and J. Suh, "A review of smartphone applications for solar photovoltaic use: Current status, limitations, and future perspectives," *Appl. Sci.*, vol. 11, no. 5, pp. 1-31, 2021, doi: 10.3390/app11052178.
- [31] M. Bekhti, "A Conceptual Solar Array Design for a Geostationary : Mini-communications Satellite for Algeria," vol. 3, no. 9, pp. 16-23, 2021.
- [32] W. An, H. Wang, and Y. Luo, "Dual-Band Antenna Integrated With Solar Cells for WLAN Applications," *Front. Phys.*, vol. 9, no. October, pp. 1-7, 2021, doi: 10.3389/fphy.2021.775214.
- [33] S. B. Thandullu Naganathan and S. Dhandapani, "Patch antenna integrated on solar cells for green wireless communication: A feature oriented survey and design issues," *Int. J. RF Microw. Comput. Eng.*, vol. 32, no. 1, pp. 1-29, 2022, doi: 10.1002/mmce.22926.
- [34] A. Ali, H. Wang, J. Lee, Y. H. Ahn, and I. Park, "Ultra-low profile solar-cell-integrated antenna with a high form factor," *Sci. Rep.*, vol. 11, no. 1, pp. 1-9, 2021, doi: 10.1038/s41598-021-00461-w.
- [35] G. A. Urdaneta, C. Meyers, and L. Rogalski, "Solar power satellites: technical challenges and economic feasibility," *Futur. Energy*, vol. 1, no. 2, pp. 9-16, 2022, doi: 10.55670/fppl.fuen.1.2.3.
- [36] M. H. Alsharif et al., "Optimization analysis of sustainable solar power system for mobile communication systems," *Comput. Mater. Contin.*, vol. 71, no. 2, pp. 3243-3255, 2022, doi: 10.32604/cmc.2022.022348.
- [37] F. M. E. Haroun, S. N. M. Deros, A. A. Alkahtani, and N. M. Din, "Towards Self-Powered WSN: The Design of Ultra-Low-Power Wireless Sensor Transmission Unit Based on Indoor Solar Energy Harvester," *Electron.*, vol. 11, no. 13, 2022, doi: 10.3390/electronics11132077.